

Use a pin vice to drill 0.35mm or #80 holes through the jig holes and into the side sill about 0.5mm deep for the handrail. Make sure that the jig is pushed up hard against the edge of the floor and drill 0.4mm or #78 holes into the floor and side sill, about 1mm deep, adjacent to the step brackets. Bend a stirrup step (5) to shape and install the pins on each end of the step into the drilled holes. Secure with superglue. Similarly, apply a drop of superglue with a pin to each of the holes drilled for the handrail and add a handrail.

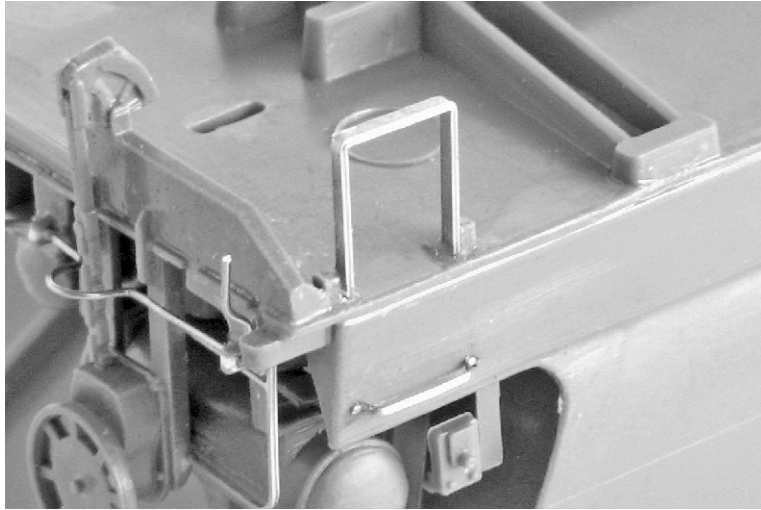

Shunters' steps

Bend the step tread (2) and step frame (3) to shape and solder the tread to the step frame. Because the parts are etched in 0.3mm brass, the step can be difficult to form, so you may prefer to substitute steps from Steam Era Models kit E6.

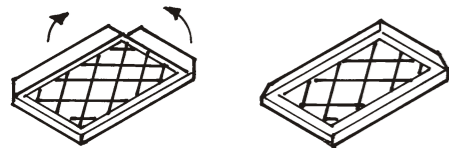
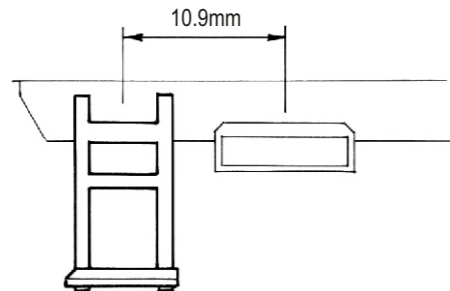
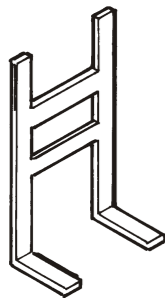
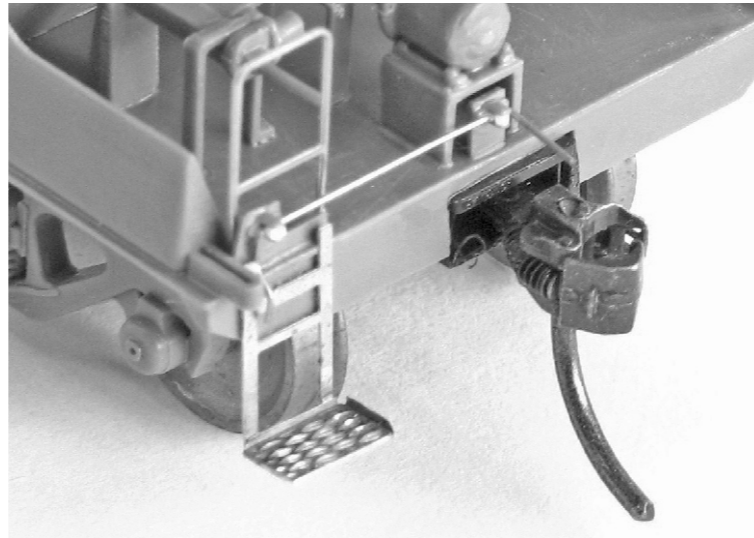

Figure 2.



Secure an assembled step to the headstocks at each end with superglue. There are notches moulded in the edge of the floor sheet to aid with positioning and the top of the step frame should be flush with the top of the L/H uncoupling lever support bracket.



Roof walkway

Remove the roof walkway from the etched fret, taking care to remove any remains of the securing tags. The appearance will also be improved if the cusp edge is carefully smoothed on the outer edges of this part, by judicious use of a flat needle file.

Careful inspection of this part will show that the support feet along the inner edge of one side have some small sections missing. This is to allow the walkway to locate against the handles moulded to the roof. Check the fit of this part and, when satisfied, apply some superglue to each of the support ribs moulded on the roof and install the etched part. There should be a gap of about 0.7mm between the transverse section of the walkway and the roof hatch at each end.

Finally, check the fit of the moulded ladder and, if necessary, carefully file a very small amount from the upper end to ensure a snug fit against the etched walkway. Secure the ladder with cement at the floor and with a drop of superglue at the top.



C/- P.O. Rhyll, Victoria, 3923.

KIT NO. E8. Walkways, handrails and steps for VHGF Grain Hopper

This kit contains etched walkways, handrails and steps as well as wire for use as piping and uncoupling levers. The walkways, handrails and steps can be used with any VHGF kit, but the piping and uncoupling levers require plastic parts only included in kits since January 2019. These instructions should be read in conjunction with those for the VHGF kit.

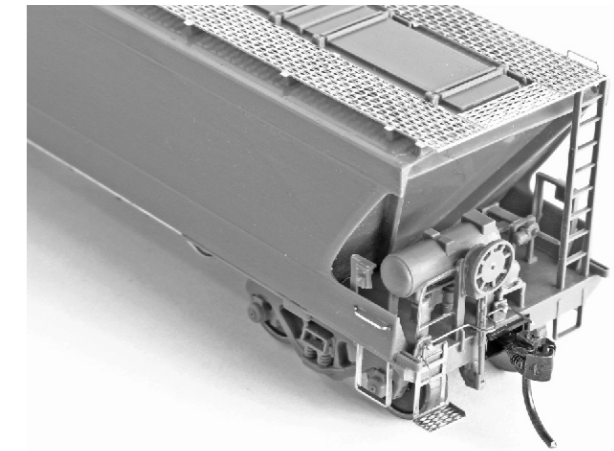

Instructions

Remove parts from the fret only as needed. Place the fret on a hard surface such as 'Masonite' and use a craft knife in a chopping motion to cut through the tags securing the part to the fret. Remove any tag remaining with a needle file. Where parts are to be folded, a half etched line is provided. The half etched line should go to the *inside* of the bend.

The brake equipment on the end platforms should be assembled as described in the VHGF instructions, with the proviso that particular attention should be given to the moulded brake cylinder supports, part 21. As far as possible the draft or taper in the upright sections of this part should be removed by careful filing, to allow room for the central uncoupling lever brackets to be installed at each end.

Shunters' handholds

Use a 0.4mm drill or small taper broach to ensure that the holes moulded in the floor at each end for the handholds are clear and the handrail can be installed with a short length lying behind the headstocks. Install etched part 6 at the handbrake end so that the horizontal legs are located in the notches moulded in the R/H edge of the handbrake support stand. Secure with a little super glue in these notches as well as behind the headstocks.

Install part 7 at the opposite end, secured with superglue behind the headstocks. Note that there are very small projections near the base of the vertical legs of this part that should rest on the top surface of the floor.

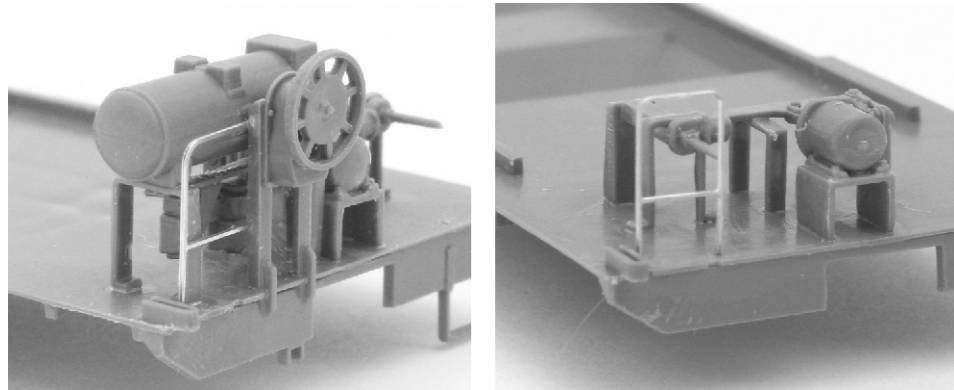

Uncoupling levers

Locate the two uncoupling lever brackets that are moulded as part of each side/end moulding. They are located near the walkway (25), at the end closest to part 24. Carefully remove them from their gates and check the fit on the floor. It will be necessary to remove the flange from the foot of the smaller bracket in order to install it at the handbrake end. The smaller brackets should have their R/H edges coincide with the centerline of the end, cemented against the brake cylinder support at the handbrake end and centred in the opening of the brake cylinder support at the other end. The face of each bracket should be in the same plane as the face of the headstocks.

The larger brackets locate close to the L/H side sill. It may be necessary to trim a small section of the base flange so that this bracket can clear the upright of the shunters' handholds. Cement each bracket in place, so they are centred over the notches in the edge of the floor, which locate the shunters' steps, and flush with the face of the headstocks.

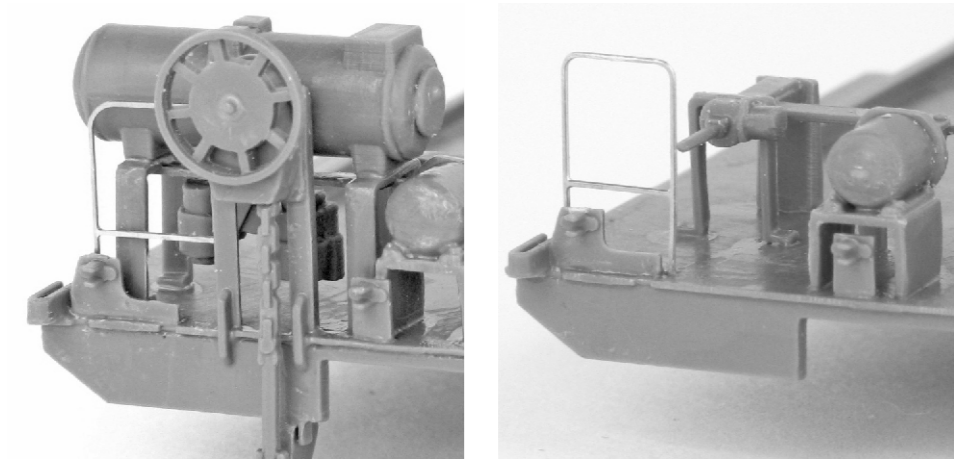

Form two uncoupling levers from the 0.3mm wire provided. The lever for the handbrake end requires a joggle to get around the handbrake chain, but that for the other end can be straight. A jig has been included on the moulding fret for the roof/floor, adjacent to the reservoir, part 6. Refer to figure 1.

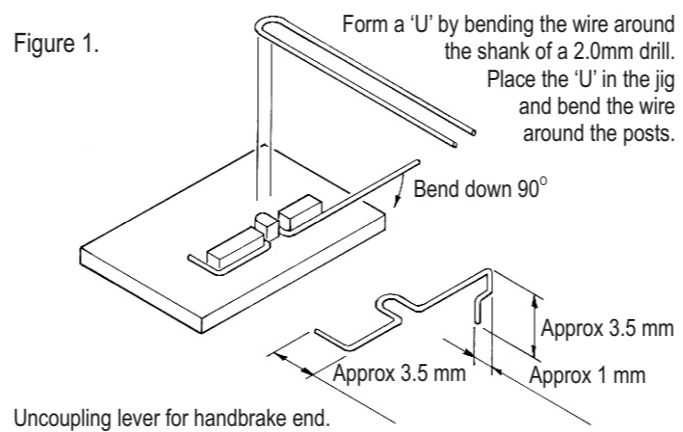

Install the levers in the brackets and retain them in position with little cubes of 0.015" polystyrene (not included).

Air piping

Assemble the body and the underframe, as described on page 4 of the kit instructions.

The air lines for the brake pipe and for the brake cylinder run in brackets below the L/H side sill, as viewed from the handbrake end. Five brackets support these pipes and four mouldings have been provided on each fret for the side/end, adjacent to the hopper door drive sockets (part 22). A rope hitch is also moulded adjacent to parts 22.

Fine scratches have been moulded in the edge of the side sill to assist with placement of the pipe brackets. Note that the brackets are **not** evenly spaced, nor symmetrical about the lateral centreline.

Cement a rope hitch to the underside of each side sill, centred exactly on the lateral centreline.

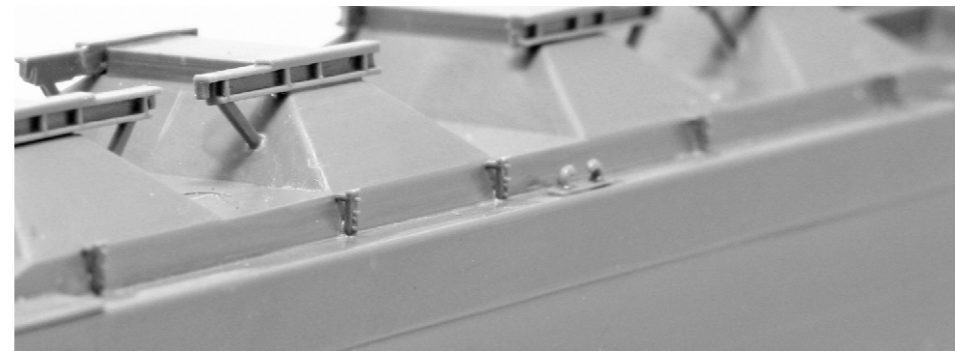

Two pipes need to be formed to shape, one from the 125mm long piece of 0.5mm wire and a second pipe to the same shape from the 125mm length of 0.3mm wire. Form one bend of 90°, about 17mm from one end, around the shank of a 3.0mm diameter drill. Place this wire on the pins which have been moulded on the runner adjacent to the plastic walkway on the side/end moulding. Make a second 90° bend around a pin to form a large 'U' shape. Ensure that all sections of the U are in the same plane and adjust if necessary.

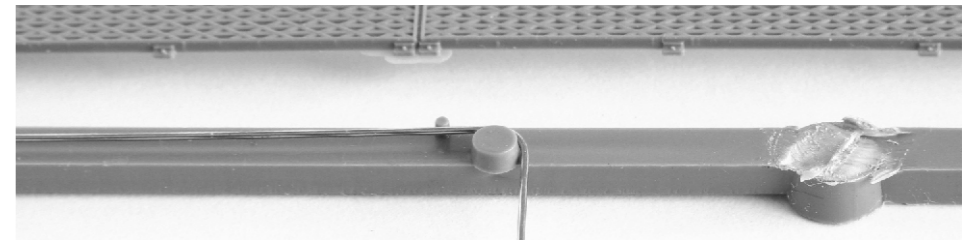

Bend a kink of 15° at each end, about 5mm from the short leg of the U. Place the formed wires in the pipe brackets and secure with superglue at each bracket and at the centre sills or hopper slope sheet.

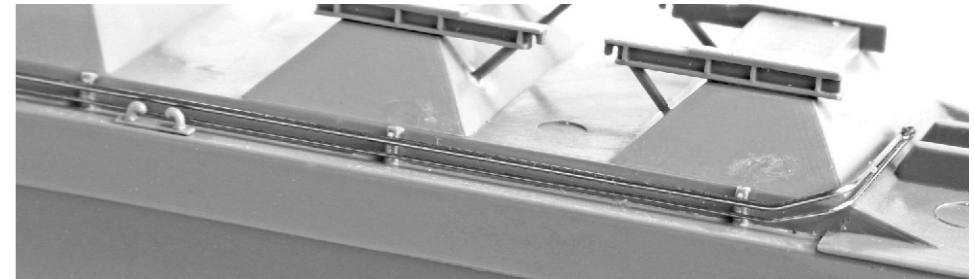

Stirrup steps and handrails

Handrails have been moulded at both ends of the side sills and brackets for locating stirrup steps are also provided on the lower surface at all four corners of the floor. Carefully shave off all the handrails and remove the step brackets where a step is not required. If possible consult a photo of a wagon, because there is some variation in the number of the steps and handrails on prototype wagons. Some wagons only have a stirrup step and handrail on the handbrake corner, others have steps and rails on both sides at the handbrake end, while other wagons have 3 or 4 stirrup steps.

Remove the drilling jig from the etched fret and fold it 90° at the half etched line. Where a step and associated handrail are to be installed, place the jig over the bottom corner of the side sill, between the step brackets.

